

Environmental Meter

Model EM54

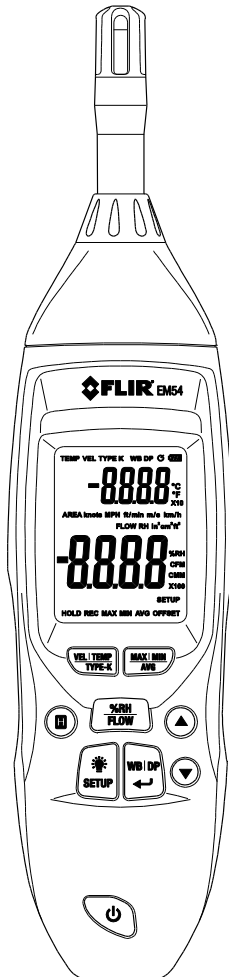

Table of Contents

1. ADVISORIES	3
1.1 Copyright	3
1.2 Quality Assurance	3
1.3 Documentation	3
1.4 Disposal of Electronic Waste	3
2. INTRODUCTION	4
3. METER DESCRIPTION	5
3.1 Front and Side Descriptions	5
3.2 Control Button Descriptions	6
3.3 LCD Description	7
4. OPERATION	9
4.1 Powering the Meter	9
4.2 Air Temperature and Relative Humidity Measurements	9
4.3 Wet Bulb and Dew Point Temperature Calculations	9
4.4 Type-K Thermocouple Measurements	9
4.5 Air Velocity Measurements	10
4.6 Airflow (Volume) Measurements	10
4.7 LCD Backlight	11
4.8 Data Hold	11
4.9 MAX-MIN-AVG Record Mode	11
4.10 Setup Mode	11
5. MAINTENANCE	12
5.1 Cleaning and Storage	12
5.2 Battery Replacement	12
5.3 Disposal of Electronic Waste	12
6. SPECIFICATIONS	13
6.1 General specifications	13
6.2 Measurement specifications	13
7. CUSTOMER SUPPORT	14
8. THREE-YEAR LIMITED WARRANTY	14

1. Advisories

1.1 Copyright

© 2019, FLIR Systems, Inc. All rights reserved worldwide. No parts of the software including source code may be reproduced, transmitted, transcribed or translated into any language or computer language in any form or by any means, electronic, magnetic, optical, manual or otherwise, without the prior written permission of FLIR Systems. The documentation must not, in whole or part, be copied, photocopied, reproduced, translated or transmitted to any electronic medium or machine-readable form without prior consent, in writing, from FLIR Systems. Names and marks appearing on the products herein are either registered trademarks or trademarks of FLIR Systems and/or its subsidiaries. All other trademarks, trade names or company names referenced herein are used for identification only and are the property of their respective owners.

1.2 Quality Assurance

The Quality Management System under which these products are developed and manufactured has been certified in accordance with the ISO 9001 standard. FLIR Systems is committed to a policy of continuous development; therefore, we reserve the right to make changes and improvements on any of the products without prior notice.

1.3 Documentation

To access the latest manuals and notifications, go to the Download tab at: <https://support.flir.com>. It only takes a few minutes to register online. In the download area you will also find the latest releases of manuals for our other products, as well as manuals for our historical and obsolete products.

1.4 Disposal of Electronic Waste



As with most electronic products, this equipment must be disposed of in an environmentally friendly way, and in accordance with existing regulations for electronic waste. Please contact your FLIR Systems representative for more details.

2. Introduction

Thank you for selecting the FLIR EM54 Environmental Meter. The EM54 measures Air Temperature, Type-K Temperature, Relative Humidity, and Air Velocity and calculates Dew Point/Wet Bulb Temperature and Airflow (volume). Visit www.flir.com/testwarranty to read the 3-Year Limited Warranty document and to register your product to receive a free 1-year warranty extension.

Features

- Dual reading, backlit multi-function display
- Measures air temperature and relative humidity via built-in temperature and relative humidity sensors
- Measures air velocity and Type-K temperature using remote probes
- Side compartment with micro USB port for vane anemometer connection and sub-miniature jack for Type-K thermocouple probe connection
- Calculates Wet Bulb and Dew Point temperature
- Calculates airflow (CFM/CMM air volume) in air ducts using an air velocity measurement and a user-programmed air duct area value
- Selectable units of measure
- MIN-MAX-AVG recording
- Programmable Auto Power OFF (APO) timer
- Low battery indication
- Setup mode for changing default settings and for entering area measurements for airflow measurements

3. Meter Description





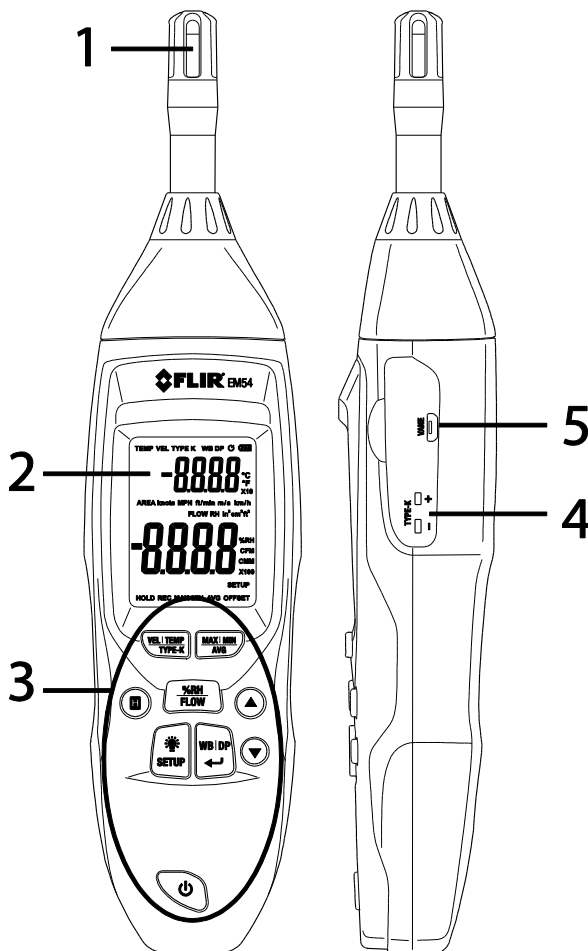

3.1 Front and Side Descriptions

1. Temperature and Relative Humidity sensors
2. Backlit LCD (see separate section)
3. Control buttons (see separate section)
4. Type-K thermocouple sub-miniature jack
5. Vane Anemometer USB probe jack

Note: Accessory mount and battery compartment on back of meter





3.2 Control Button Descriptions

	<p>Long press to power ON or OFF</p>
<p>VEL TEMP TYPE-K</p>	<p>Short press to switch between Air Velocity (VEL), Air Temperature (TEMP), and Thermocouple Temperature (Type-K) measurements (upper display digits). Air Velocity and Type-K measurements require attachment of remote probes</p>
<p>WB DP</p>	<p>Short press to switch between Wet Bulb and Dew Point temperature displays (upper display digits)</p>
<p>%RH FLOW</p>	<p>Short press to switch between Relative Humidity, Airflow, and Area modes</p>
	<p>Short press to access/exit Data Hold (freeze displayed reading)</p>
<p>MAX MIN AVG</p>	<p>Short press to step through MAX, MIN, and AVG recording (REC) memories. Long press to exit and clear memories.</p>
	<p>Short press to switch LCD backlight ON or OFF</p>
<p>SETUP</p>	<p>Long press to access/exit the SETUP mode</p>
	<p>Return button. See SETUP mode section for programming steps requiring use of this button</p>
	<p>In normal operation, short press to change the measurement units for the upper display digits. See SETUP mode section for programming steps that require use of this button</p>
	<p>In normal operation, short press to change the measurement units for the lower display digits. See SETUP mode section for programming steps that require use of this button</p>

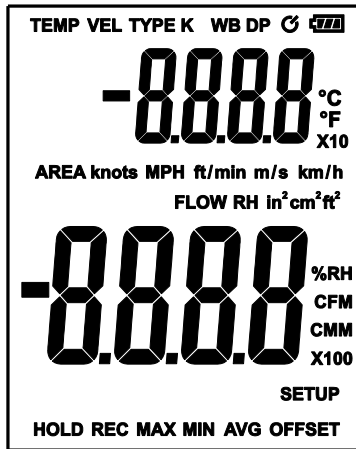
3.3 LCD Description



TEMP	Air Temperature mode
VEL	Air Velocity mode (remote anemometer probe)
TYPE K	Type-K Thermocouple mode (remote Type-K probe)
WB	Wet Bulb temperature calculation
DP	Dew Point temperature calculation
	Auto Power OFF active icon (see Setup mode)
	Battery status
°C/°F	Temperature units of measure
x10	Multiply the display value by 10
AREA	Area measurement entered by user -- for airflow (volume) measurements
Knots	Unit of measure for air velocity
MPH	Unit of measure for air velocity (miles per hour)
Ft/min	Unit of measure for air velocity (feet per minute)

m/s	Unit of measure for air velocity (meters per second)
Km/h	Unit of measure for air velocity (kilometers per hour)
FLOW	Airflow (CMM/CFM air volume) mode
RH / %RH	Relative humidity mode / Relative humidity unit of measure
in²	Square inches (unit of measure for duct Area calculations)
cm²	Square centimeters (unit of measure for Area calculations)
ft²	Square feet (unit of measure for Area calculations)
CFM	Cubic feet per minute (unit of measure for airflow volume)
CMM	Cubic meters per minute (unit of measure for airflow volume)
x100	Multiply the displayed value by 100
SETUP	Appears when Setup mode is accessed
HOLD	Data Hold mode
REC	Appears when the MAX-MIN-AVG mode is accessed
MAX	Maximum reading
MIN	Minimum reading
AVG	Average reading
OFFSET	Appears in the Setup mode when programming a temperature display offset for the Type-K thermocouple mode
OL or -OL	Out-of-range temperature measurement
-----	Type-K probe not connected
-8888	Upper display digits
-8888	Lower display digits

4. Operation

4.1 Powering the Meter

The meter is powered by one 9V battery (rear compartment). Long press the power button  to switch the meter ON or OFF. The EM54 has an APO Sleep utility that switches the meter OFF automatically after the programmable APO time has elapsed. See the Setup mode for instructions on setting the sleep mode (SLP) APO timer.

4.2 Air Temperature and Relative Humidity Measurements

1. Temperature and RH sensors are located at the tip of the meter
2. Long press the power button to switch the meter ON
3. Short press the **VEL|TEMP|TYPE-K** button to step to the Air Temperature mode (**TEMP**). The upper digits show the reading; short press  to toggle °C/°F
4. Short press the **%RH|FLOW** button to select **RH** for display on the lower digits
5. If a measurement is out of range, the display will show 'OL' or '-OL'.



4.3 Wet Bulb and Dew Point Temperature Calculations

Wet Bulb and Dew Point Temperature calculations are based on air temperature and relative humidity measurements.

1. Long press the power button to switch the meter ON
2. Short press the **WB|DP** button to toggle Wet Bulb (**WB**) and Dew Point (**DP**) temperature modes. The upper digits show the reading

4.4 Type-K Thermocouple Measurements

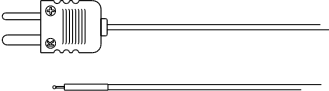
Caution: Note the temperature range limit printed on the thermocouple connector (or verify the range with the manufacturer). The supplied probe cannot be used to measure temperature through the entire range listed in the specification section; measuring temperature beyond the range printed on the thermocouple connector can damage the probe and the meter.

1. Connect a Type-K thermocouple sub-miniature plug (shown here) to the jack in the meter's right-side compartment. 
2. Short press **VEL|TEMP|TYPE-K** to step to the **TYPE-K** mode
3. Touch the thermocouple probe tip to the surface under test or hold in air; the upper display digits show the reading. Short press  to select °C or °F units
4. If the thermocouple is not connected to the meter when the Type-K mode is selected, the display will show dashes
5. If a temperature measurement is out of range, the display will show 'OL' or '-OL'.
6. See the Setup mode section for setting a temperature display offset, if desired

4.5 Air Velocity Measurements

1. Refer to the Vane Anemometer probe illustration on the right. Connect the probe's plug (2) into the USB jack in the meter's side (right) compartment
2. Short press the **VEL|TEMP|TYPE-K** button to step to the Air Velocity mode (**VEL**)
3. Hold the probe by the handle (3) and place the vane (1) in the flow of air and view the air velocity readings on the upper display digits
4. Short press **▲** to select the units: m/s, ft/min, km/hr, MPH, or knots. To set a default unit of measure see the Setup mode section

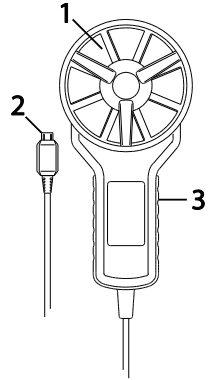

4.6 Airflow (Volume) Measurements

1. Measure the Area of the air duct under test. Refer to the *Area Equations* below for help on calculating area for rectangular/circular ducts and for useful calculations.
2. Connect the Vane Anemometer to the USB jack on the meter
3. Short press the **%RH|FLOW** button to select **FLOW**. Press **▼** to select CFM (cubic feet per minute) or CMM (cubic meters per minute) for the Airflow (volume) measurement units
4. Long press the **SETUP** button to access the Setup mode and then press **▲** 4 times to step to the **AREA** screen
5. Press Return (**↵**) and use the arrows (**▼▲**) to select the Area Units: in², cm², or ft²
6. Press Return to access the **SIZE** screen. Press Return again and use the arrows to select the decimal placement for the area value (note the x10 and x100 multipliers on the display)
7. Press Return and use the arrows to adjust the flashing digit for the area value. Use the **H** button to select a new digit to edit. Continue in this way until the area of the duct under test is accurately entered
8. Press Return to confirm the area value and then long press **SETUP** to exit
9. Insert the vane sensor in the air duct and read the airflow (volume of air) value on the lower display digits

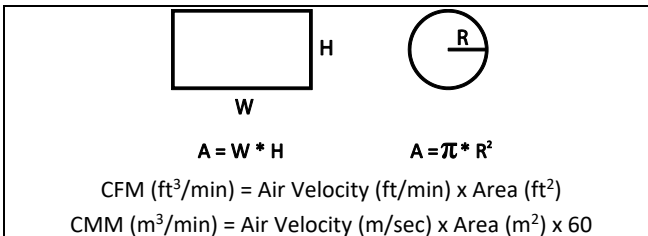

AREA EQUATIONS



4.7 LCD Backlight

Long press the  backlight button to toggle the LCD backlight ON and OFF. Note that excessive use of the backlight will shorten battery life.

4.8 Data Hold

In Data Hold mode, the displayed reading is locked. To enter/exit Data Hold mode, short press the  button. In Data Hold mode, the  indicator is displayed.

4.9 MAX-MIN-AVG Record Mode

Short press the **MAX|MIN/AVG** button to activate the recording mode, the **REC** display icon will appear indicating that the meter is now recording. Short press the **MAX|MIN/AVG** button to step through the Maximum-Minimum-Average readings. Long press **MAX|MIN/AVG** to exit the recording mode.

4.10 Setup Mode

1. Long press the **SETUP** button*
2. The first screen is the default **TEMP UNIT** for air temperature. Press Return to see the setting. Use the arrows to set °C or °F
3. Press Return to see **TYPE K OFFSET**. Press Return again and use the arrows to select a temperature offset, if desired
4. Press Return to see **VEL UNITS**. Press Return again to see the default units. Use the arrows to select m/s, ft/min, km/hr, MPH, or knots
5. Press Return to see **FLOW UNITS**. Press Return again to see the default Airflow units; use the arrows to select CFM or CMM
6. Press Return to see **AREA UNIT**. Press Return again to see the default area units and use the arrows to change to in², cm², or ft²
7. Press Return to see **AREA SIZE**, press Return again and use the arrows to select the decimal position for the area value. Press Return and use the arrows to adjust the flashing digit. Use the **H** button to select a new digit to edit. Continue in this way until the area of the duct is accurately entered
8. Press Return to see **SLP** (sleep). Press Return to see the default APO time. Use the arrows to set timer to 5, 10, 15, 20, 25, 30, 40, 60 minutes or OFF
9. Long press the **SETUP** button to exit the Setup mode

**Note that after you gain programming experience, you can use the arrows immediately after you enter the Setup mode to quickly step through the Setup parameters.*

5. Maintenance

5.1 Cleaning and Storage

Wipe the housing with a damp cloth as needed. Do not use abrasives or solvents. If the meter is not to be used for an extended period, remove the battery and store separately.

5.2 Battery Replacement

To replace the battery:

1. Switch the meter OFF
2. Disconnect all remote probes from the meter's side compartment
3. Remove the screw that secures the rear battery compartment
4. Remove the battery compartment cover
5. Remove the old battery
6. Install new battery observing correct polarity
7. Close the compartment and secure with the screw before operating the meter

5.3 Disposal of Electronic Waste

As with most electronic products, this equipment must be disposed of in an environmentally friendly way, and in accordance with existing regulations for electronic waste. Please contact your FLIR Systems representative for more details.

6. Specifications

6.1 General specifications

Battery power	9V battery
Auto Power OFF	Selectable APO sleep timer in Setup mode
Operating Conditions	32 ~ 122°F (0 ~ 50°C)
Storage Conditions	14 ~ 140°F (-10 ~ 60°C)
Meter Weight	10 oz. (283.9g) with battery installed and no external probes attached
Meter Dimensions	L x W x H: 10.8 x 2.6 x 1.8 in. (275 x 65 x 45mm)
Safety Compliance	CE and RCM
Drop test	3.3 ft. (1m) not including removeable probes
Accessories	9V battery, Type-K probe, Vane Anemometer probe, carry pouch, accessory/tripod mount, Quick Start document

6.2 Measurement specifications

Measurement	Range	Resolution	Accuracy
Air Temperature	-22 ~ 140°F (-30 ~ 60°C)	1°F (0.1°C)	±1.8°F (±1.0°C) 50° ~ 86°F (10° ~ 30°C) ±3.6°F (±2.0°C) -22° ~ 50°F (-30° ~ 9.9°C) and 88° ~ 140°F (31° ~ 60°C)
Relative Humidity	5 ~ 98%	0.1%	±3.5%
Dew Point	-22°F ~ 140°F (-30°C ~ 60°C)	1°F (0.1°C)	±4.8°F (3°C)
Wet Bulb	-22°F ~ 122°F (-30°C ~ 50°C)	1°F (0.1°C)	±4.8°F (3°C)
Type-K Temperature	-148°F ~ 2502°F (-99.9°C ~ 1372°C) NOTE: The supplied Type-K probe cannot be used to measure temperature > rating printed on the connector	1°F (0.1°C)	± (1.5% +1.8°F [1.0°C]) -148° ~ 212°F (-99.9° ~ 99.9°C) ± (1.5% +3.6°F [2.0°C]) 212° ~ 2502°F (100° ~ 1372°C)
Air Velocity	0.4 ~ 30 (m/s) 79 ~ 5906 (ft/min) 1.4 ~ 108.0 (km/h) 0.9 ~ 67.2 (mph) 0.8 ~ 58.3 (knots)	0.01 (m/s) 1 (ft/min) 0.1 (km/h) 0.1 (mph) 0.1 (knots)	± (3% + 0.2 m/s) ± (3% + 39 ft/min) ± (3% + 0.7 km/h) ± (3% + 0.4 mph) ± (3% + 0.4 knots)
Airflow	0 ~ 999900 CFM 0 ~ 999900 CMM	0.001 ~ 100 0.001 ~ 100	Airflow is a calculation; airflow accuracy is dependent on the air velocity accuracy (specification listed above)

7. Customer Support

Repair, Calibration, and Technical Support	https://support.flir.com
--	---

8. Three-Year Limited Warranty

This product is protected by FLIR's 3-Year Limited Warranty. Visit www.flir.com/testwarranty to read the 3-Year Limited Warranty document. Register your product at the website to receive a free 1-year warranty extension.



Corporate Headquarters

FLIR Systems, Inc.
2770 SW Parkway Avenue
Wilsonville, OR 97070 USA

Customer Support

Repair, Calibration, and Technical Support: <https://support.flir.com>

Publication Identification No.:	EM54-en-US
Release Version:	AA
Release Date:	March 2019
Language:	en-US